

WP.26



10

ACHTER DE HOVEN

BLS C

2<sup>a</sup>

Deze tekening vervaagt: B.V.S. - 1963		
	Naam	Datum
Get.		
Gecalq.	S.S.I. <i>[Handwritten Signature]</i>	31-5-63
Gecontr.	<i>[Handwritten Signature]</i>	12-6-63
Goedgek.	APPEL <i>[Handwritten Signature]</i>	14-6-63
N.V. NEDERLANDSCHE SPOORWEGEN		LEEUWARDE 9 2/14
Dienst: Spoorwegen		
Afd: 2		

V 20 50 50

WP.26

ACHTER DE HOVEN

KM 27.000

KM 27.125  
VOOR AKD 27 B.1

KM 27.245  
AKD 27 B.1 C EN 27 B.2

KM 27.500

KM 27.650

2 318  
BLK C

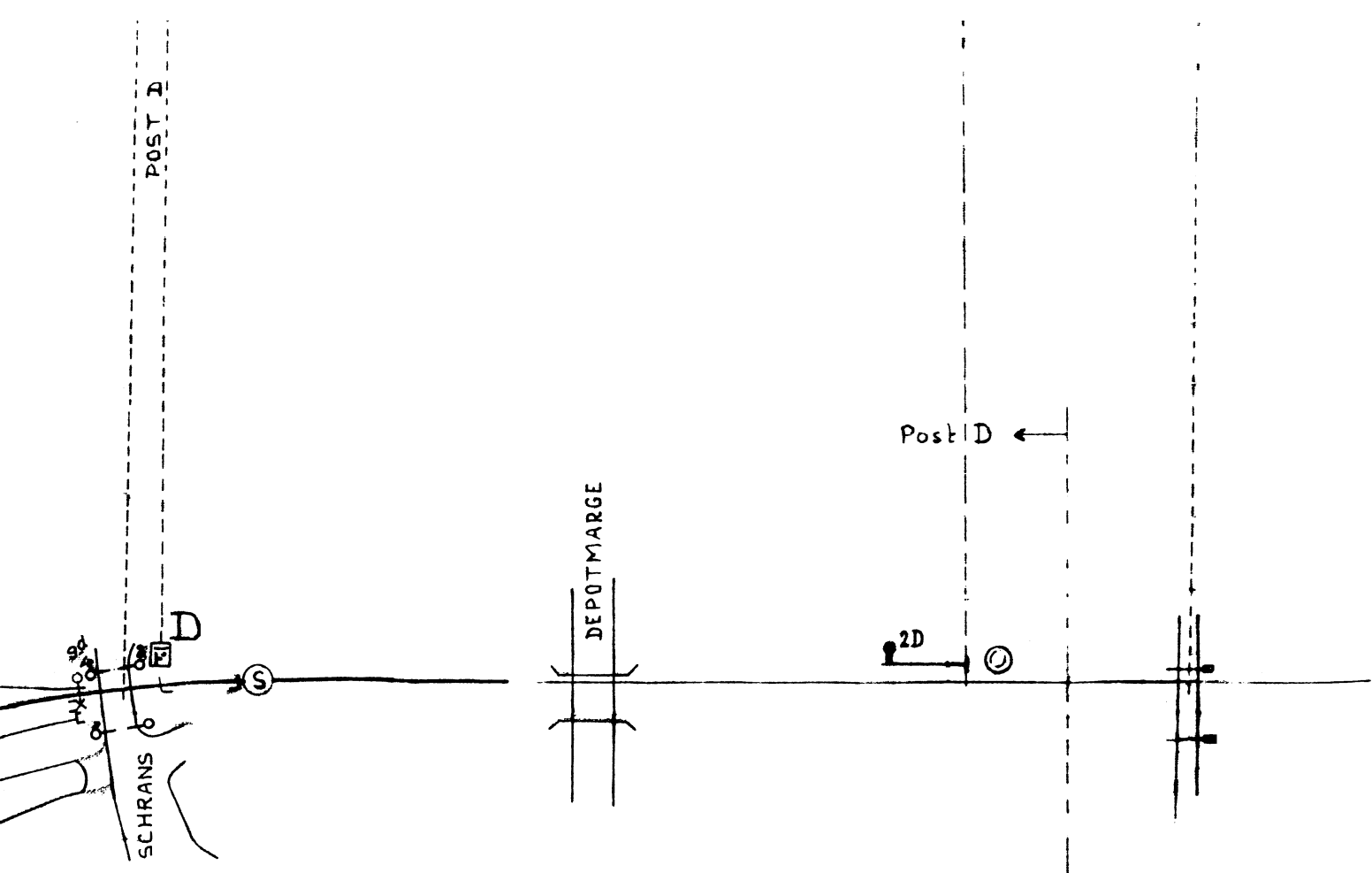

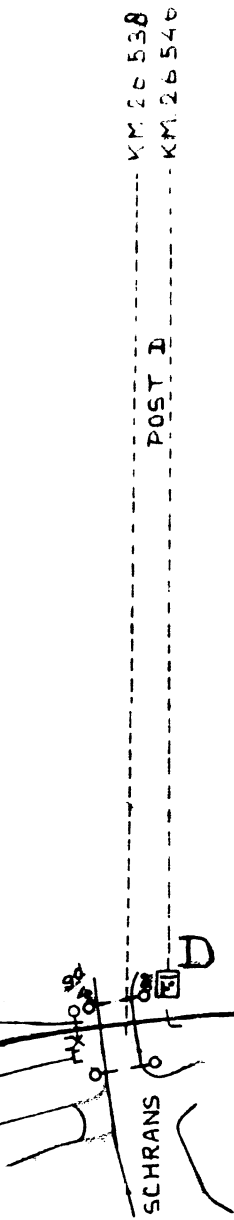

DEPOTMARGE

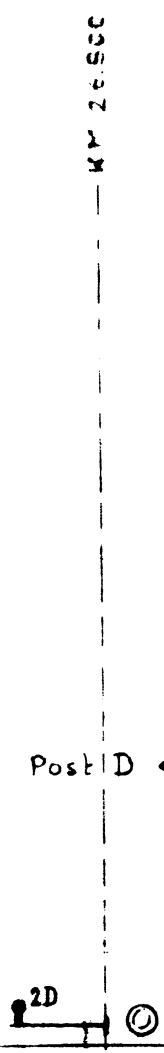

KM 26500

KM 26500

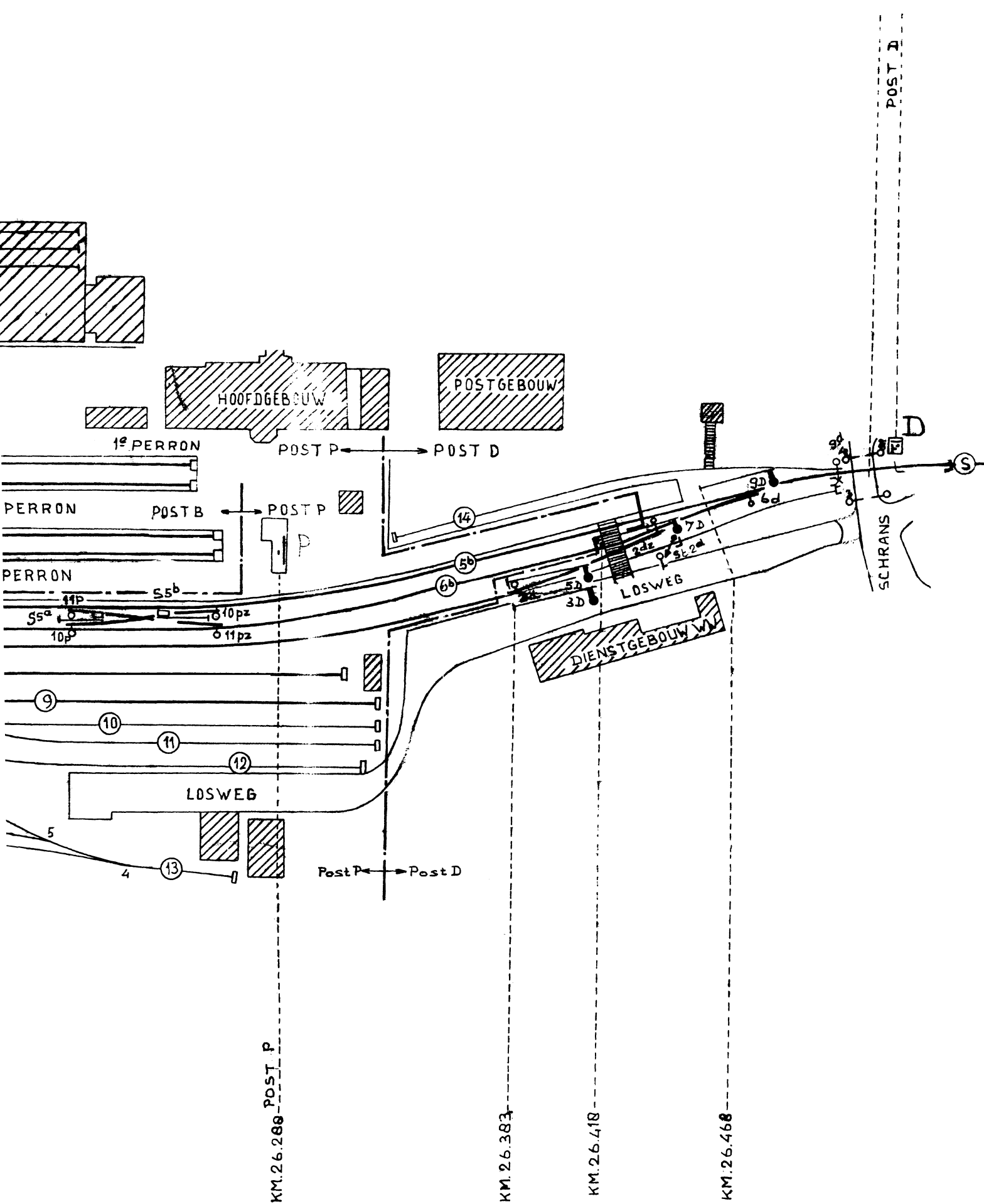

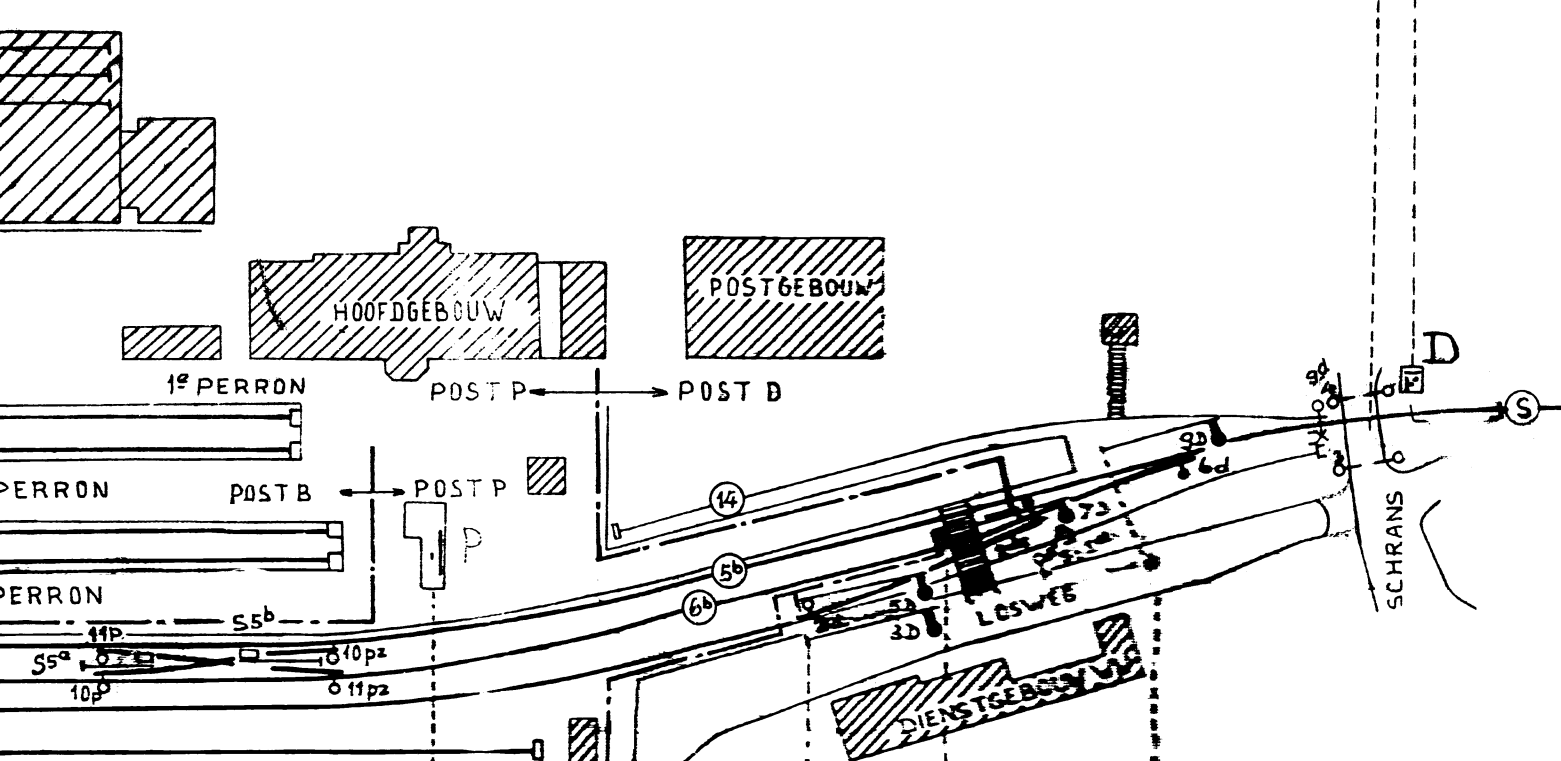
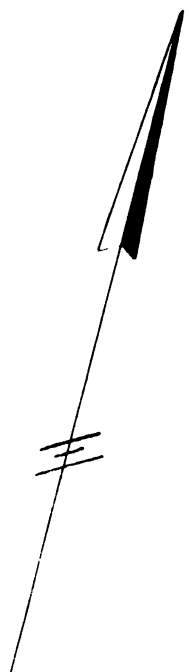

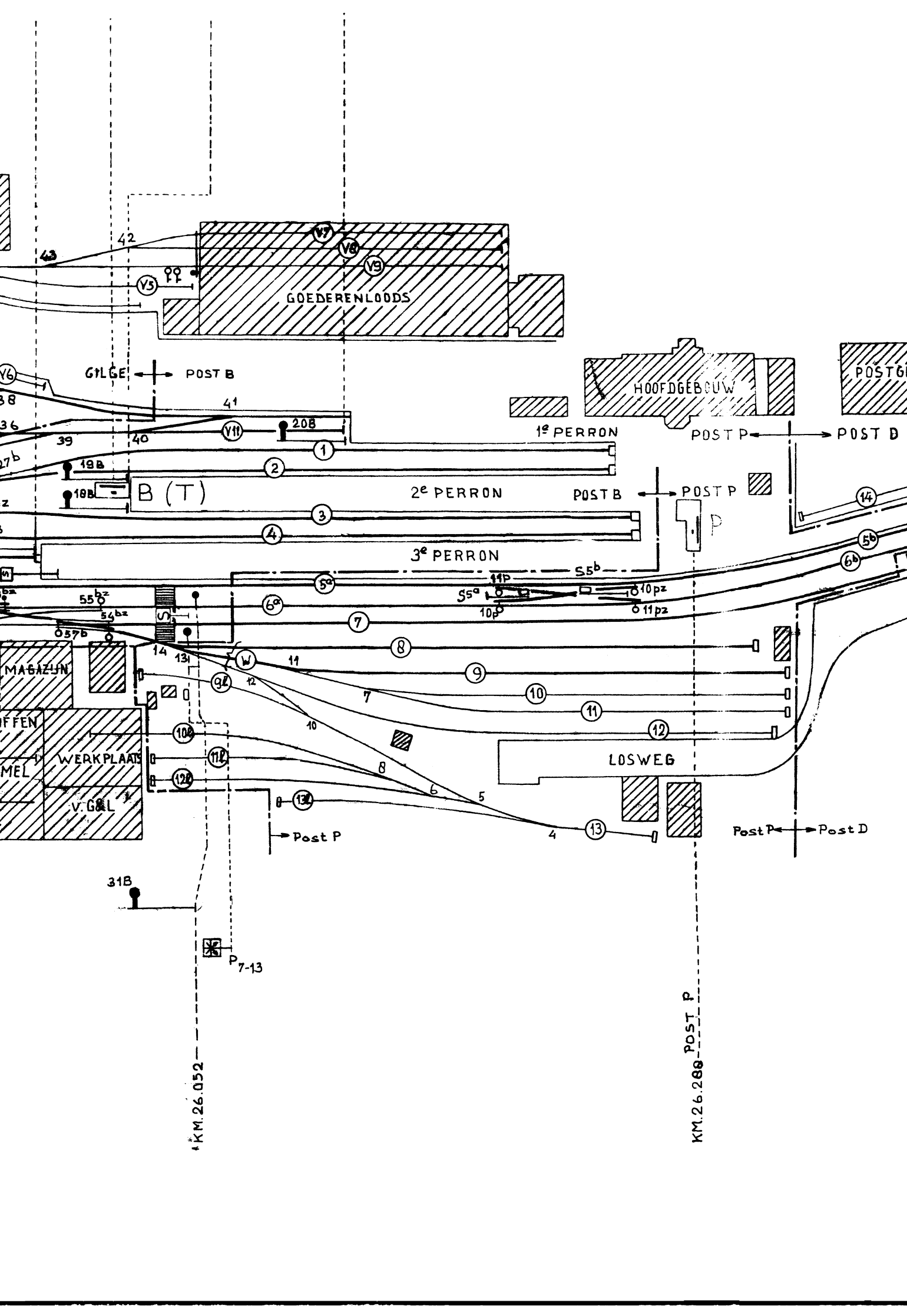

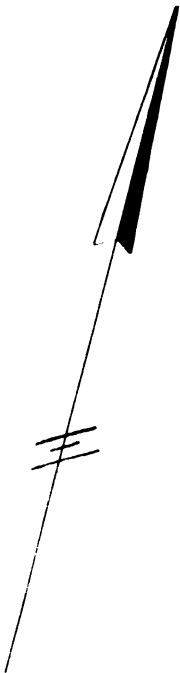

K.M. 25.987

POST B - K.M. 26.027

K.M. 26.035

K.M. 26.128

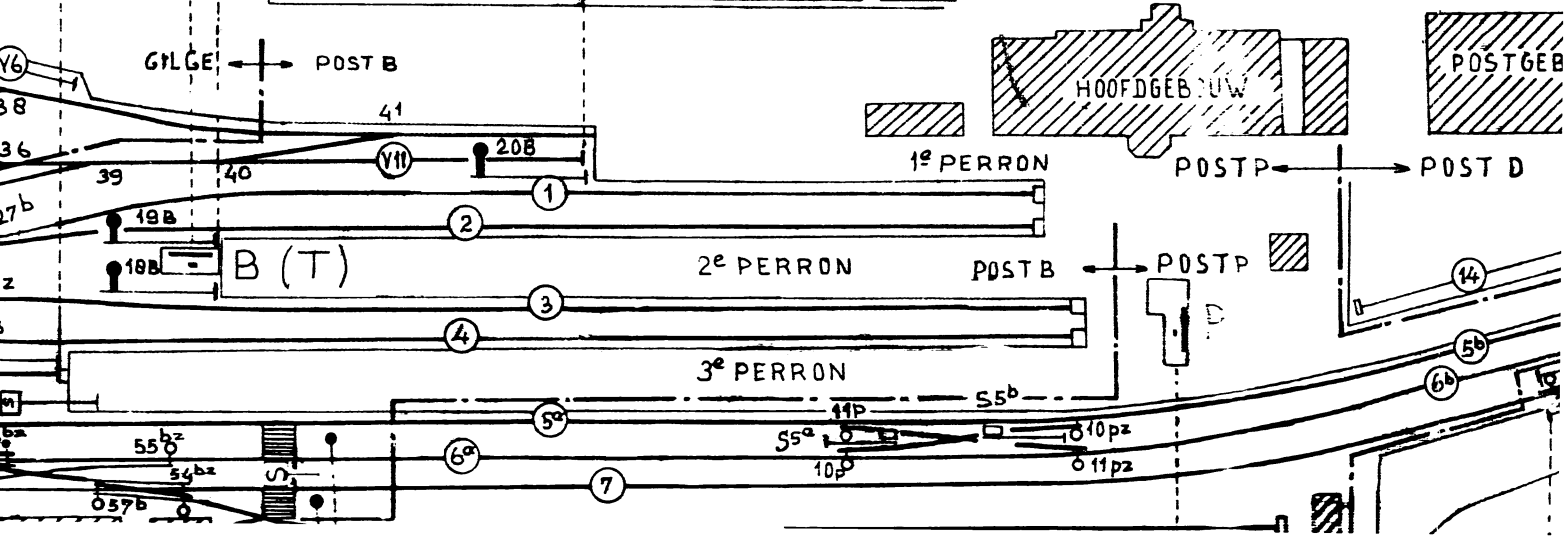
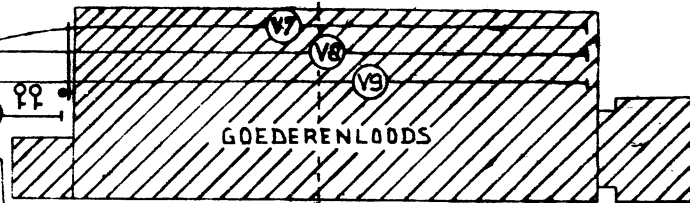



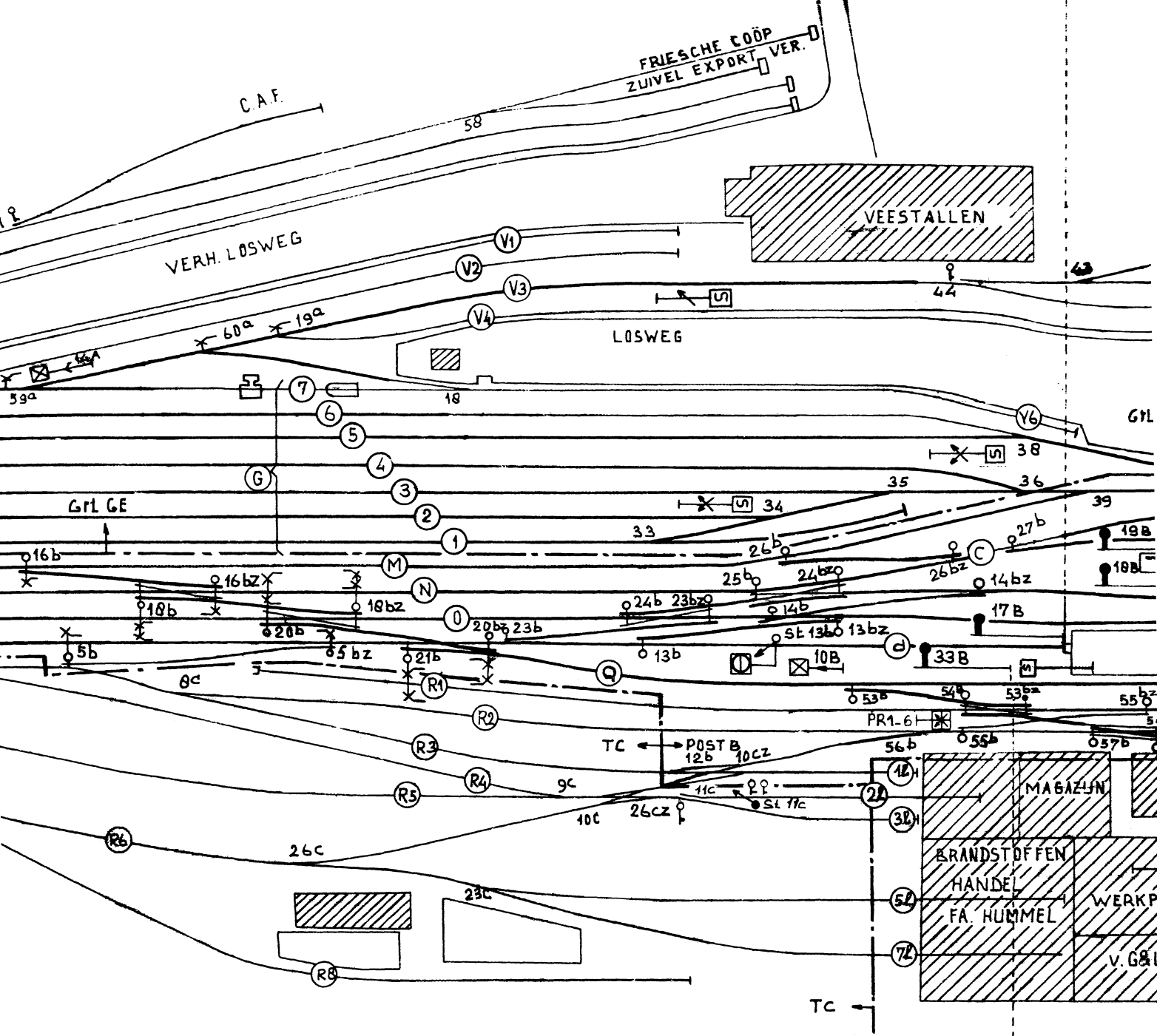

KM. 2.5.073

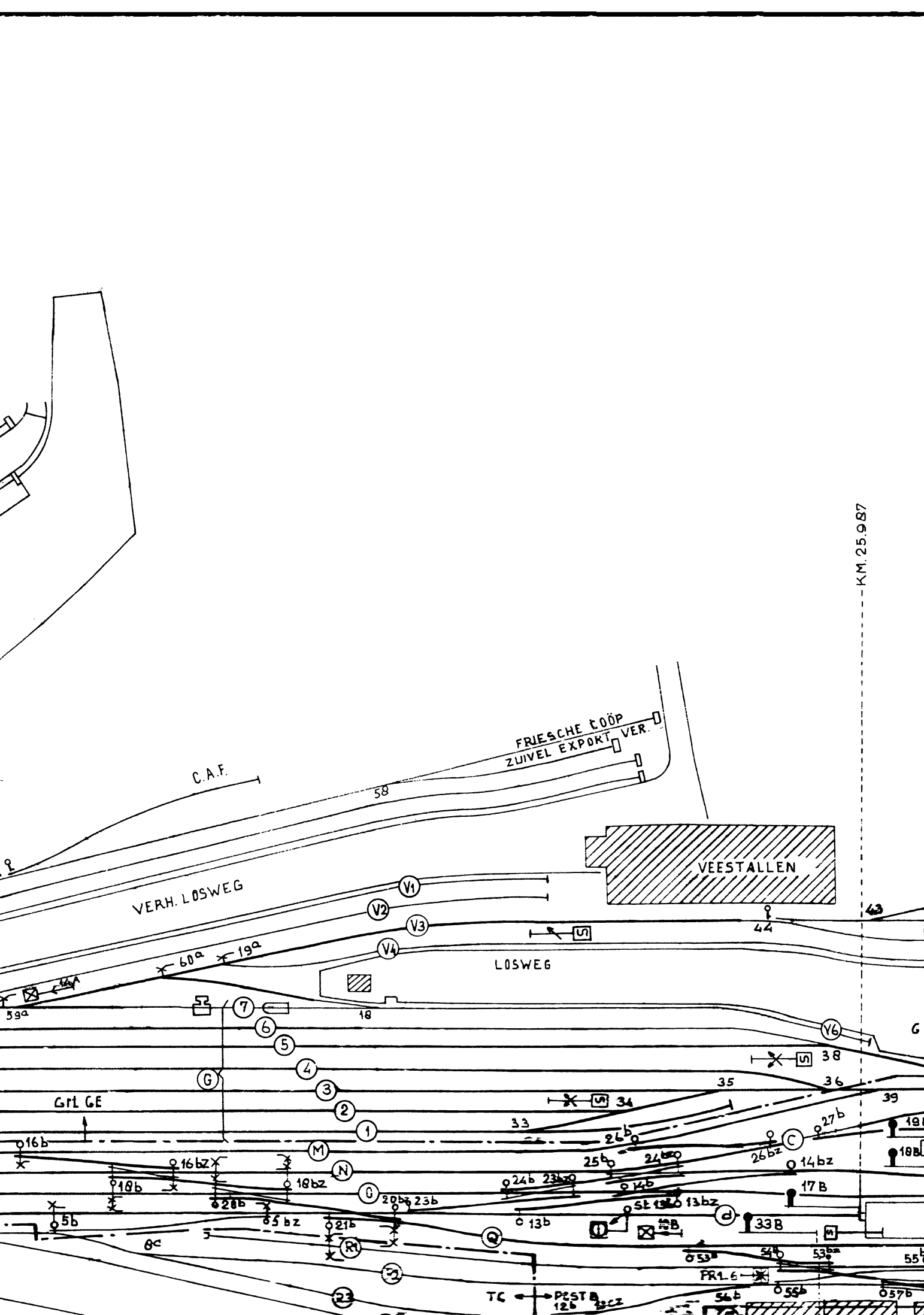

K.M. 25.9.87

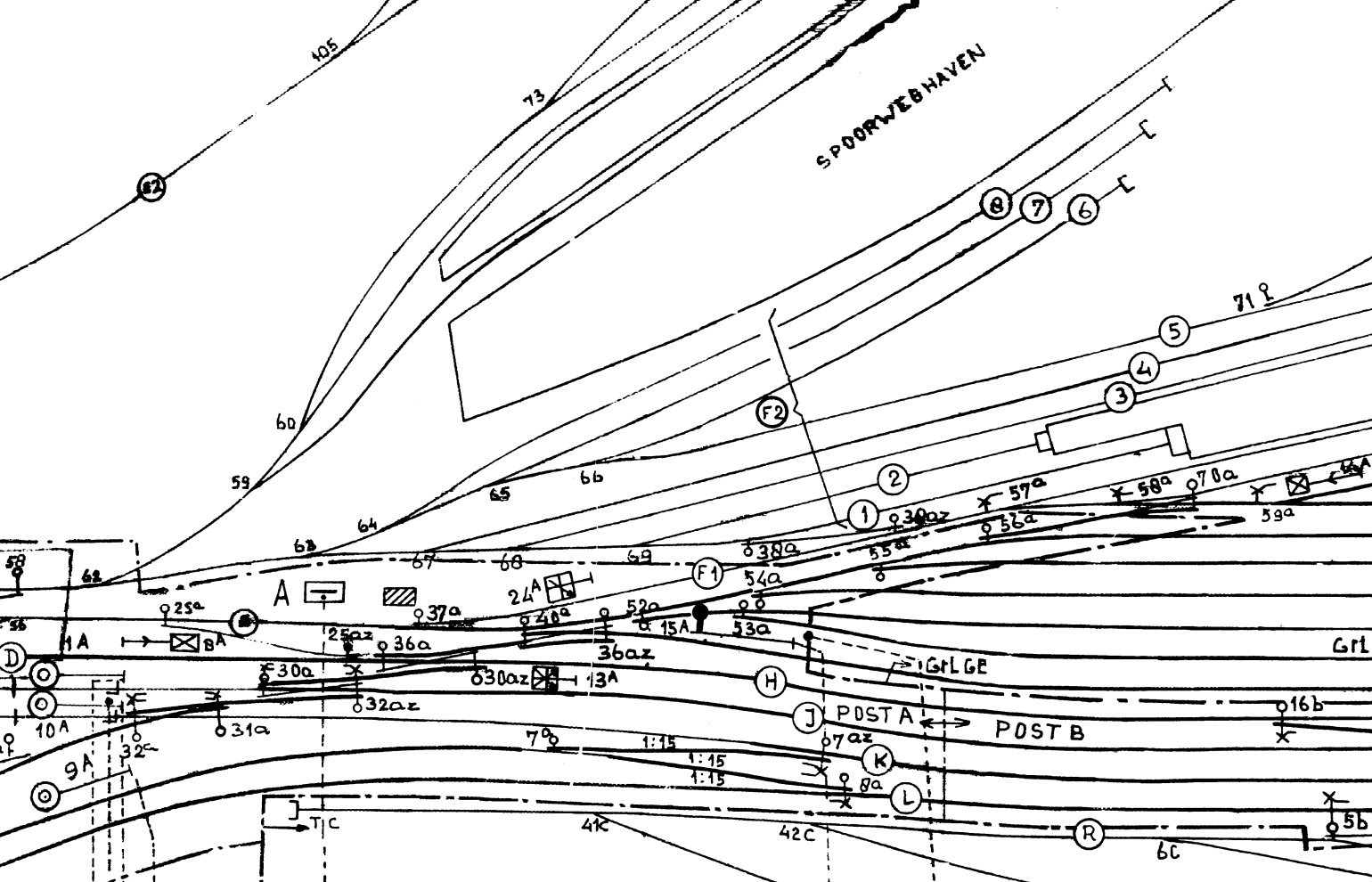

KM. 25.273  
 KM. 1.027  
 KM. 165.982

KM 166.026  
 KM 0.983  
 KM 25.397  
 KM 0.974

KM. 25.458  
 KM. 25.463

Hlg-Nsch  
 Lw-Slv  
 Va-Lw

POST A  
 Va-Lw  
 Lw-Slv  
 Hlg-Nsch  
 Lw-Dkm

POST A  
 POST B

KM. 25.458  
 KM. 25.463

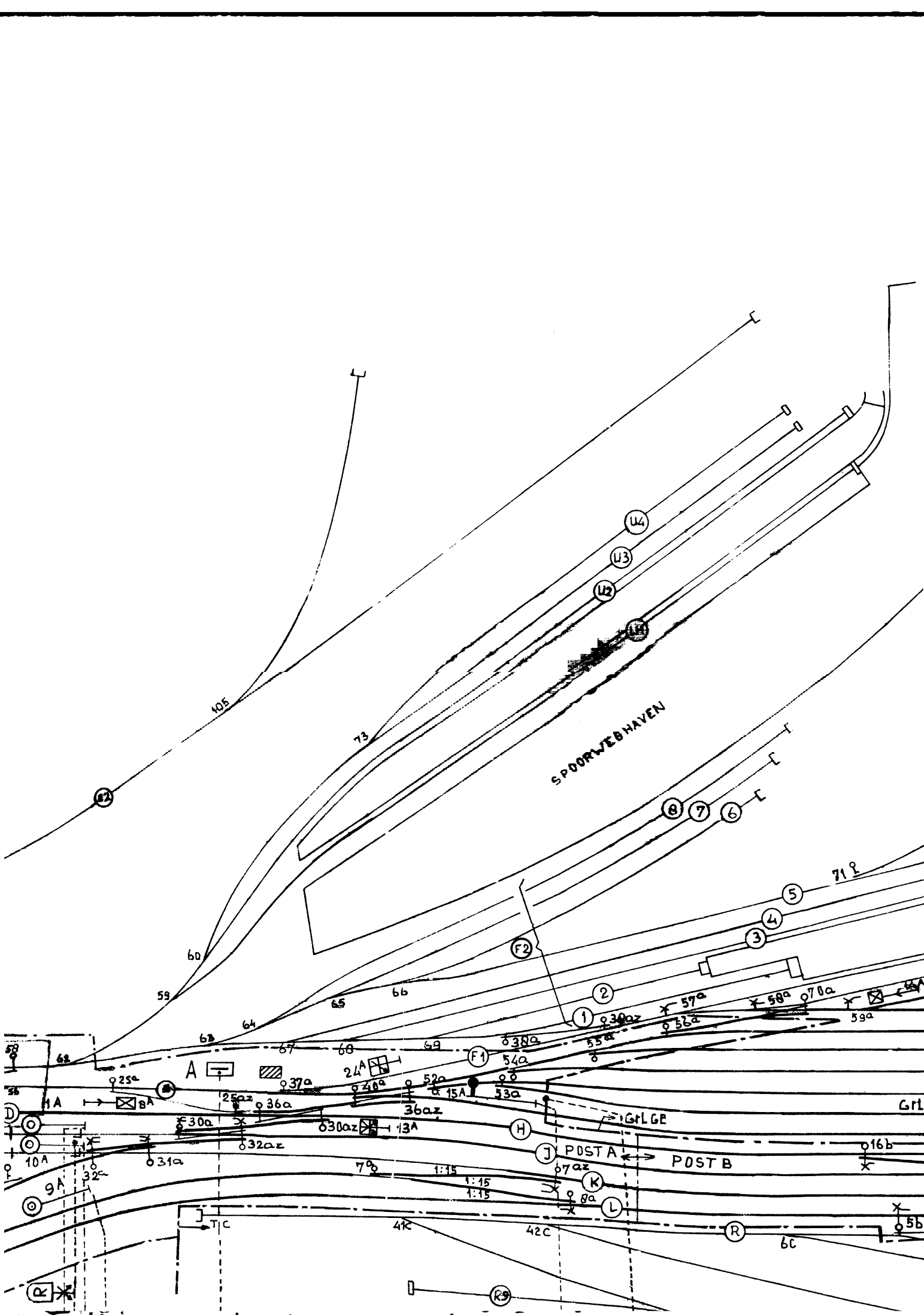

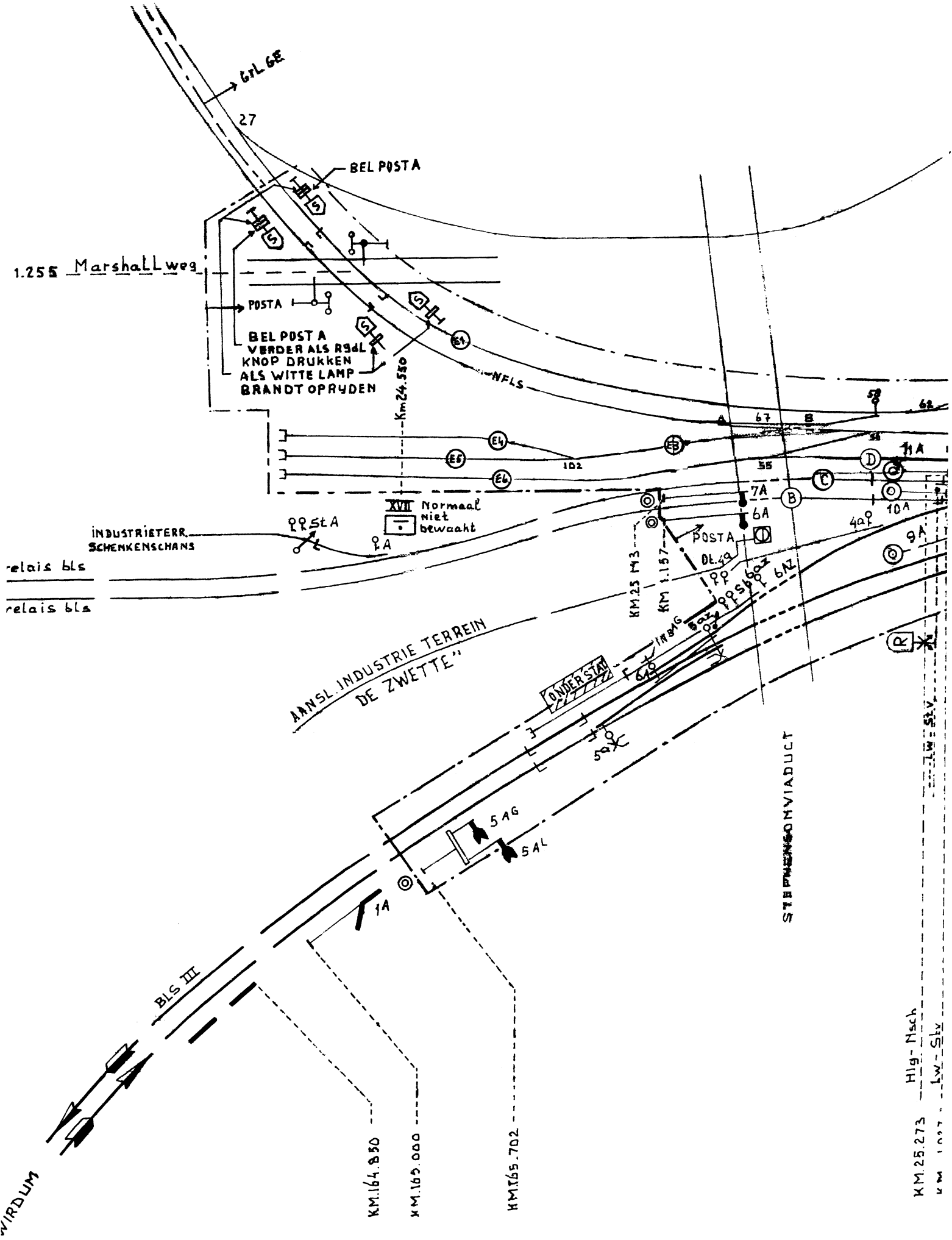

67L 6E

27

BEL POSTA

1.255 Marshallweg

POSTA

BEL POSTA  
VERDER ALS R9dL  
KNOP DRUKKEN  
ALS WITTE LAMP  
BRANDT OPRYDEN

Km 24.550

XVII Normaal  
niet  
bewaakt

INDUSTRIETERR.  
SCHENKENSCHANS

relais b1c

relais b1a

ANSL. INDUSTRIE TERREIN  
DE ZWETTE

ONDERSTAD

STEFANSONVIADUCT

BLS III

WIRDLUM

KM. 164.850

KM. 165.000

KM. 165.702

KM. 25.273

KM. 1027

Hlg-Nisch  
Lw-Sty

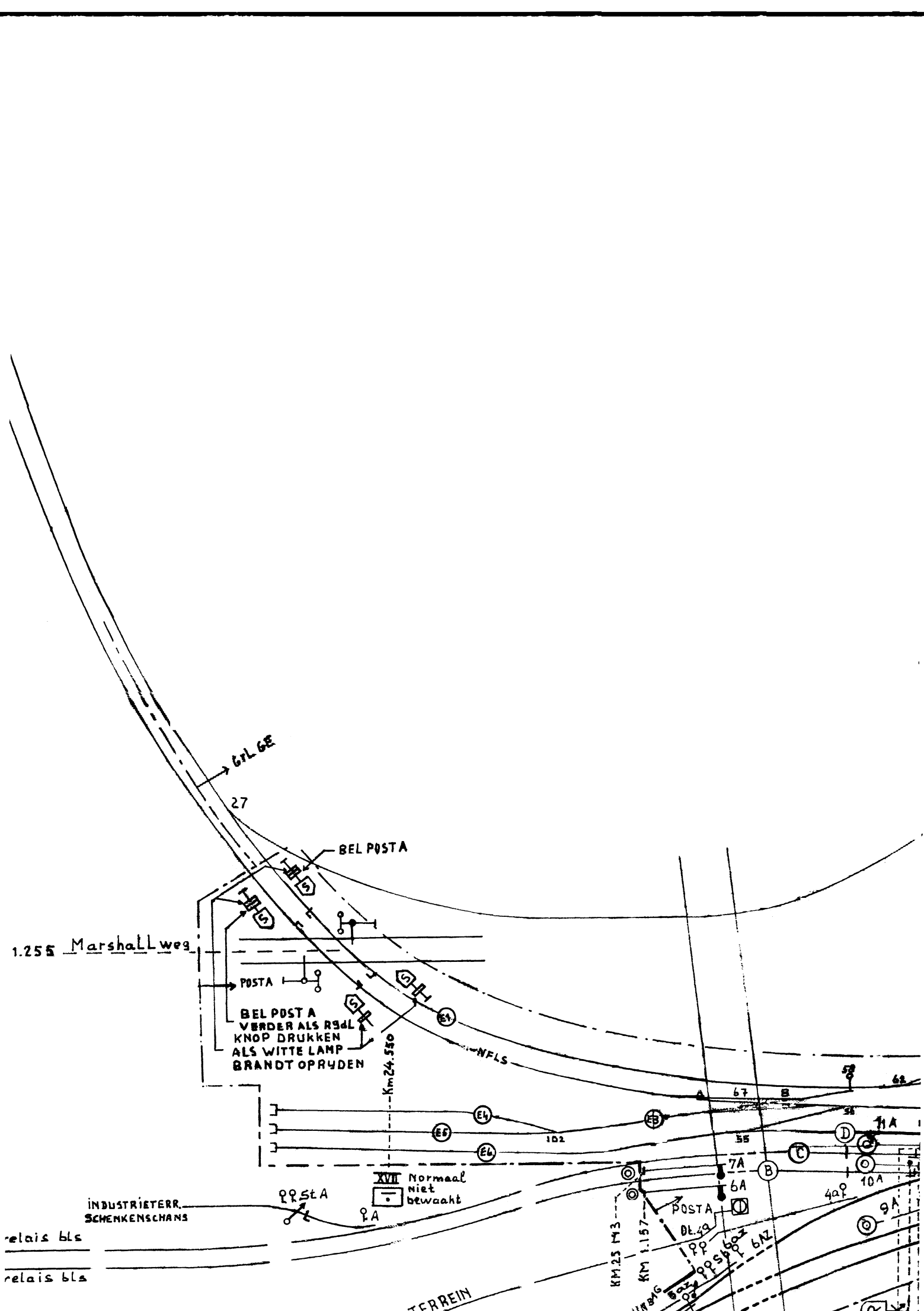

→ G.L. 6E

27

BEL POST A

1.255 Marshallweg

POSTA

BEL POST A  
VERDER ALS R9dL  
KNOP DRUKKEN  
ALS WITTE LAMP  
BRANDT OPRYDEN

Km 24.550

XVII Normaal  
niet  
bewaakt

INDUSTRIETERR.  
SCHENKENSCHANS

relais bla

relais bla

TERREIN

KM 25.157

KM 24.550

POSTA

DE 50

PP

PPSt A

6A

6B

7A

7B

7C

7D

7E

7F

7G

7H

7I

7J

7K

7L

7M

7N

7O

7P

7Q

7R

7S

7T

7U

7V

7W

7X

7Y

7Z

8A

8B

8C

8D

8E

8F

8G

8H

8I

8J

8K

8L

8M

8N

8O

8P

8Q

8R

8S

8T

8U

8V

8W

8X

8Y

8Z

9A

9B

9C

9D

9E

9F

9G

9H

9I

9J

9K

9L

9M

9N

9O

9P

9Q

9R

9S

9T

9U

9V

9W

9X

9Y

9Z

10A

10B

10C

10D

10E

10F

10G

10H

10I

10J

10K

10L

10M

10N

10O

10P

10Q

10R

10S

10T

10U

10V

10W

10X

10Y

10Z

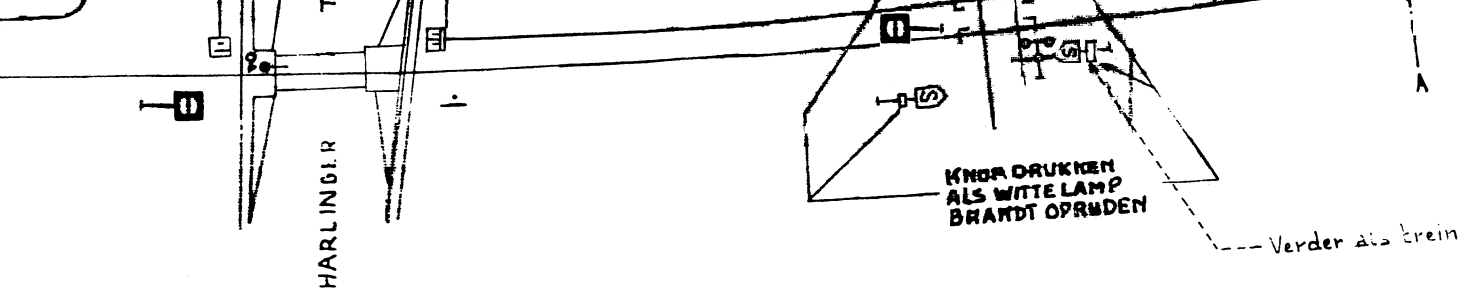

km 1.255

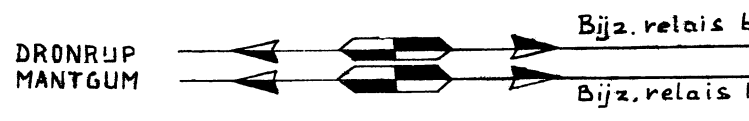

WIRDLUM

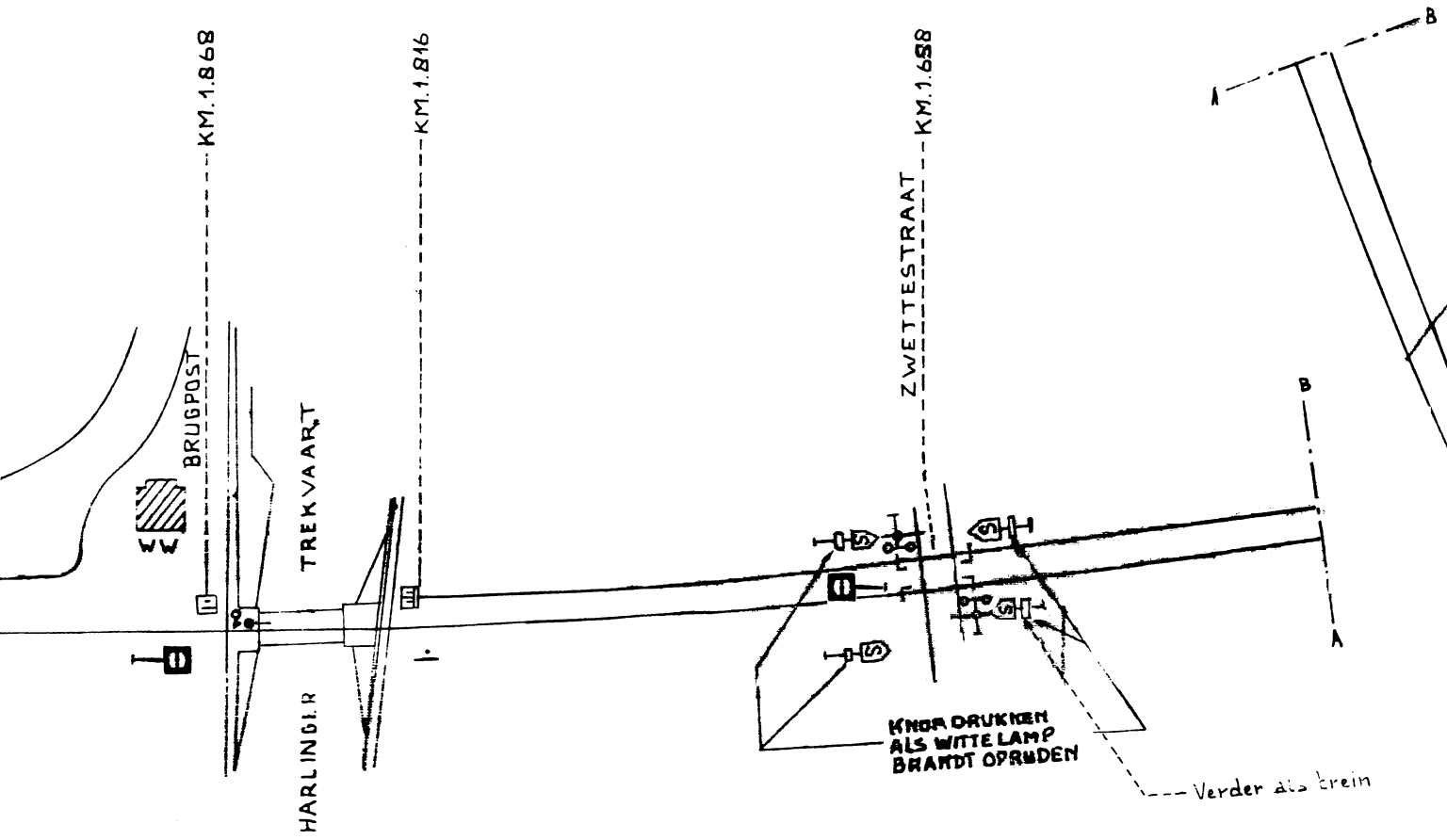

km 1.255 -

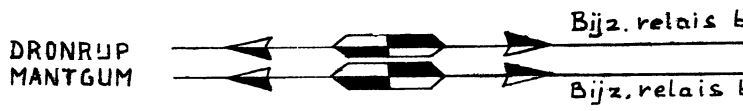



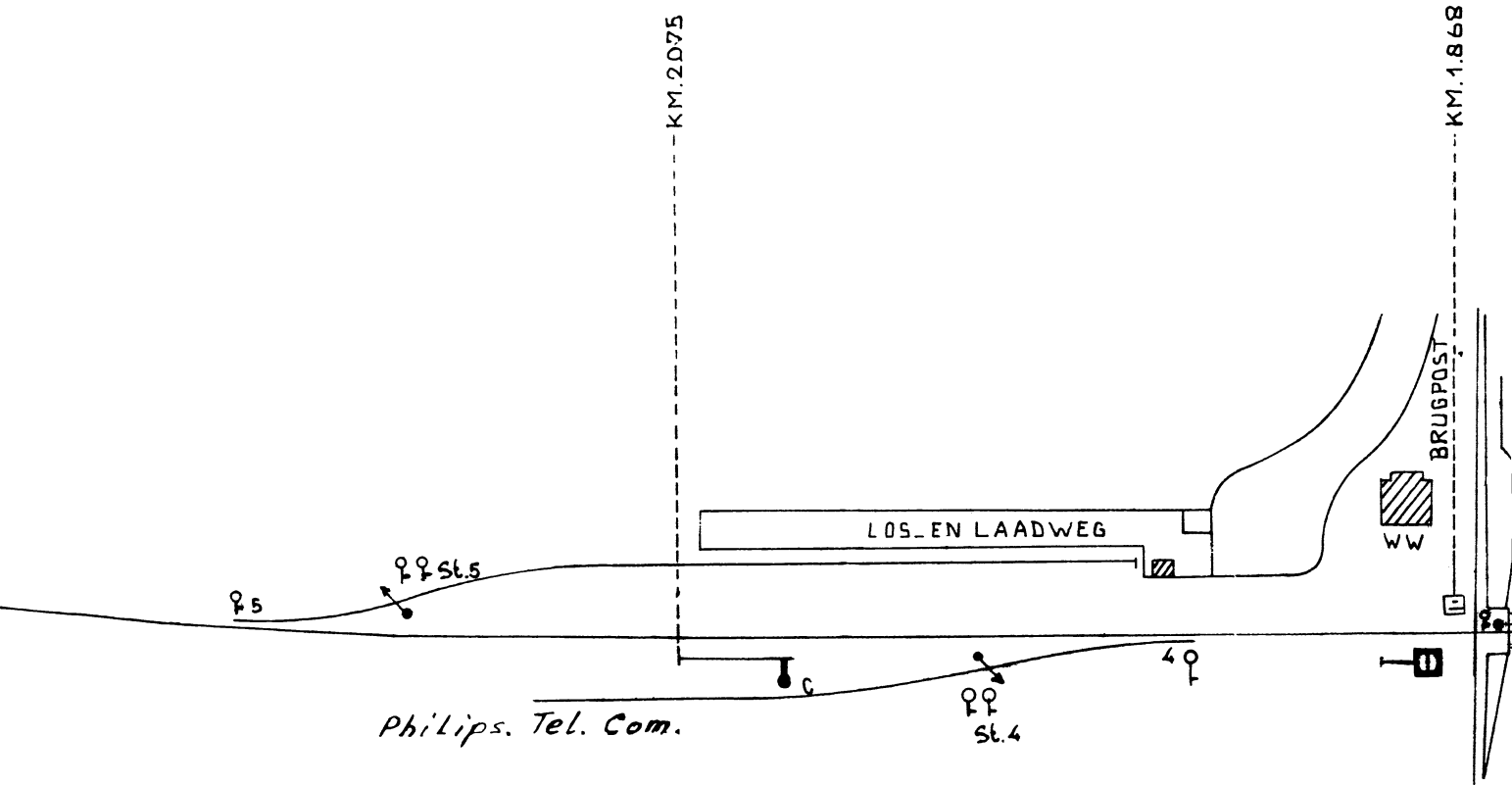

STIENS Geen BLs

